



TECHNICAL DATA SHEET

Low-Voltage current sensor

Phase current sensor
L005R-21

Non-conventional -
instrument current transformer



Description

The low voltage current sensor range offers a cost efficient solution for low voltage applications. The sensor has a wide range behaviour up to 10 times of the nominal current. The output of the sensor is according the IEC standard and is compatible to standard devices e.g. SICAM FCM. The sensor is covered by a housing for multipurpose application on busbars or cables.

Features

- No calibration on site is needed
- Class 1 or 0,5 acc. IEC61869-10
- Wide range behaviour
- Cost efficient and robust design
- For cable diameters up to 21mm
- Accuracy over complete lifespan

Dimensions

The sensor is inside a plastic housing. The secondary connection is done with screw terminals, the primary fixation is done by 2 screws, which presses the sensor against the busbar/cable.

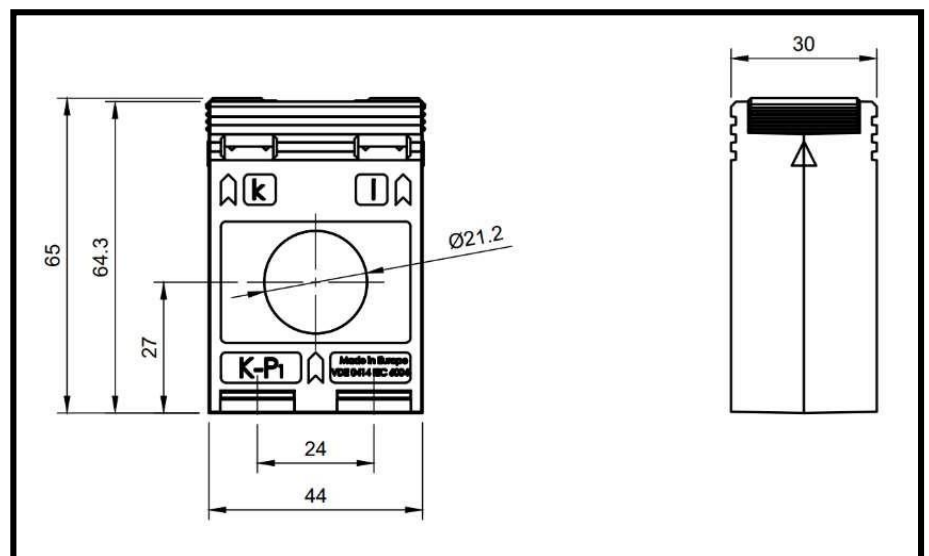

Installation

The low voltage current sensors are simple to install. The sensor is shifted on the primary busbar of a low voltage distribution switch gear.

There are some important points that must be considered during the installation process:

- Always power down before installation
- Due to the design of this product, there is no danger of high voltages, if the sensor is not short circuited or connected to a measurement device
- The sensor could be installed directly on blank busbars

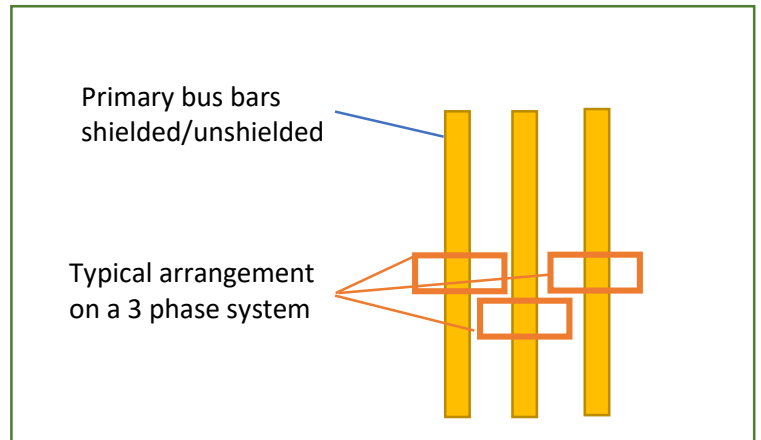

Connection

The current sensor is directly connected to a measurement device, like the Siemens SICAM FCM. 3 Phase sensors are usually used as standard configuration

Sensor must not be earthed to the switch-gear or the measurement device. Fix the current sensor with the cable tie to the medium voltage cable.

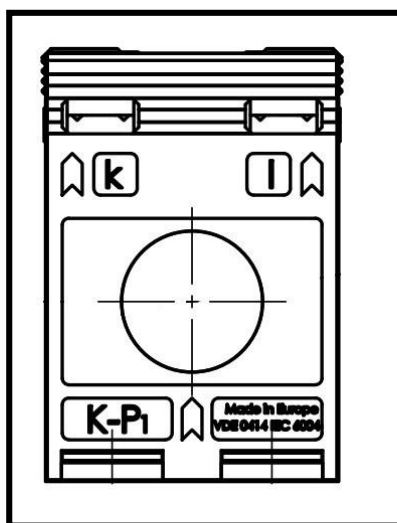
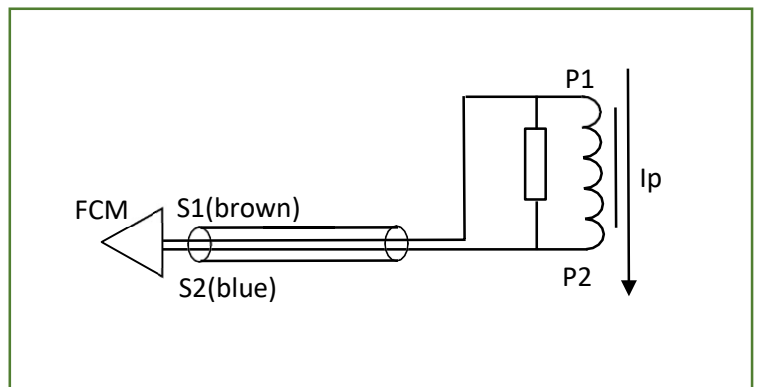

Pay attention to the P1, P2 marking

Specification

Applied Standards:	IEC61869-1, IEC61869-6, IEC61869-10
Primary current:	50A, Ext. 500% (for 50A to 250A rated currents)
Secondary output:	225mV
Burden:	$\geq 20k\Omega$
Rated short time thermal current:	25kA, 1s
Isolation voltage:	720V _{AC} /3kV/-
Accuracy class:	1 or 0,5
Operating temperature range:	-25°C to +65°C
Storage temperature range:	-40°C to +80°C
Frequency:	50 and 60Hz
Cable:	2pole, shielded cable, 7m, open ends (brown-S1, blue-S2)

Issue: 01.05.2020

Instrument Transformers Limited, 2/4 Lithgow Place, East Kilbride. Scotland G74 1PW. U.K.
t: +44 (0) 1355 236 057 e: sales@itl-uk.com w: itl-uk.com